

# Why Couldn't the Two Elephants Go Swimming Together?

Give the measure of each numbered angle. Find your answer in the Code Key and notice the letter next to it. Write this letter in the box containing the number of the angle.  
(Assume that lines in each figure that do not intersect are parallel.)

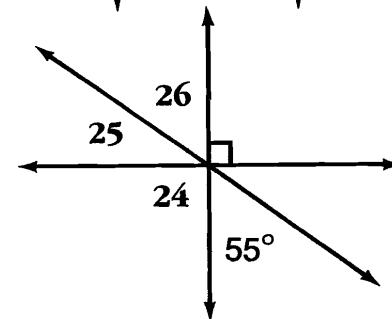
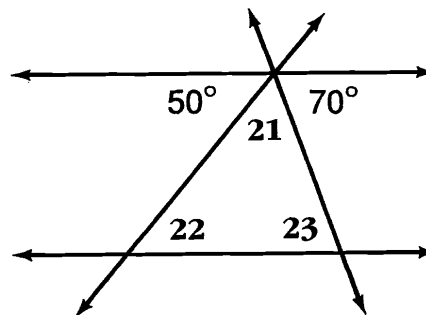
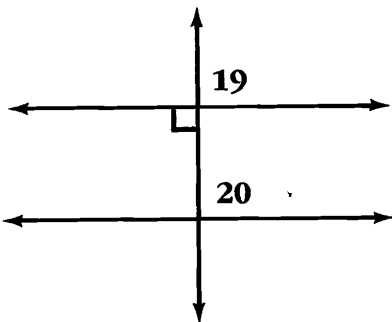
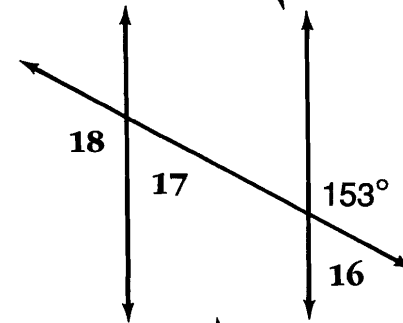
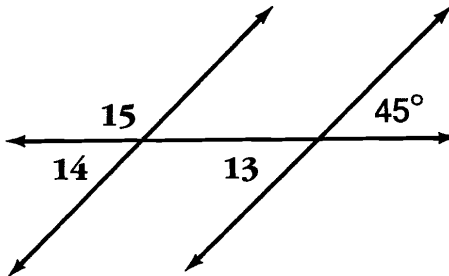
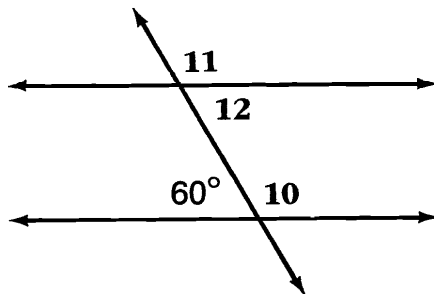
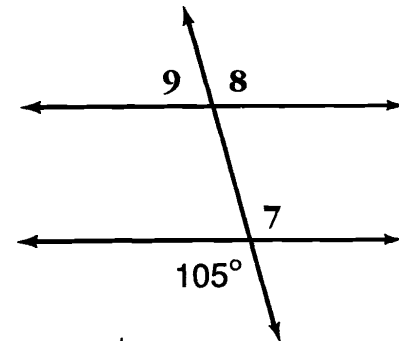
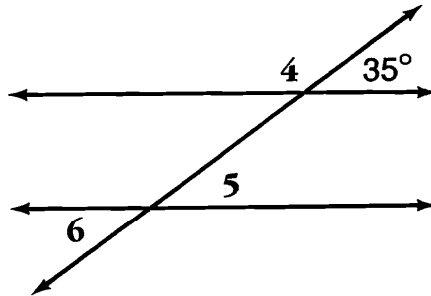
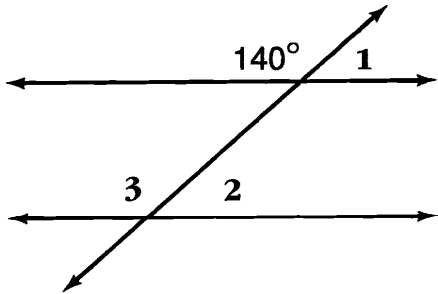

CODE KEY	
27°	A
35°	O
40°	R
45°	Y
50°	I
55°	P
60°	T
70°	U
75°	F
90°	N
105°	H
120°	E
135°	K
140°	L
145°	S
153°	D

12	7	10	14	8	16	18	6	20	3	13	25	19	11	26	17	22	1	5	9	21	2	23	24	15	4
----	---	----	----	---	----	----	---	----	---	----	----	----	----	----	----	----	---	---	---	----	---	----	----	----	---

### How Did the Judge Find Out About the Rotten Milk?

Do each exercise and find your answer in the Code Key. Notice the letter next to the answer. Write this letter in the box containing the number for the exercise.

I. Complete each statement.

- Two angles are complementary if the sum of their measures is  $90^\circ$ .
- Two angles are supplementary if the sum of their measures is  $180^\circ$ .
- The complement of a  $30^\circ$  angle has a measure of  $60^\circ$ .
- The supplement of a  $65^\circ$  angle has a measure of  $115^\circ$ .

II. Find the measure of each numbered angle.

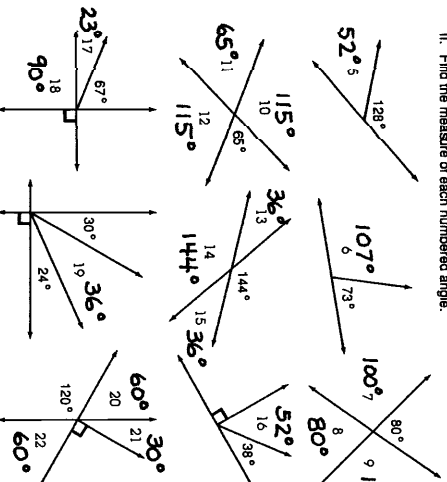

CODE KEY	KEY
23°	D
30°	Q
36°	T
52°	A
60°	R
65°	U
80°	I
90°	O
100°	H
107°	S
115°	E
144°	W
180°	N



13 7 12 3 10 14 16 6 18 17 1 20 8 2 19 9 4 21 11 5 22 15  
T H E R E W A S O D O R I N T H E Q U A R T

D-31

TOPIC 3-9: Related Angles Formed by Intersecting Lines

### Why Couldn't the Two Elephants Go Swimming Together?

Give the measure of each numbered angle. Find your answer in the Code Key and notice the letter next to it. Write this letter in the box containing the number of the angle. (Assume that lines in each figure that do not intersect are parallel.)

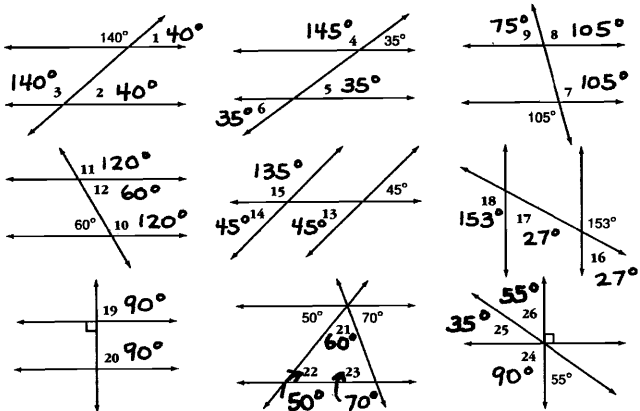

CODE KEY	KEY
27°	A
35°	O
40°	R
45°	Y
50°	I
55°	P
60°	T
70°	U
75°	F
90°	N
105°	H
120°	E
135°	K
140°	L
145°	S
153°	D

12 7 10 14 8 16 18 6 20 3 13 25 19 11 26 17 22 1 18 5 9 21 23 24 15 4 20 3 13 25 19 11 26 17 22 1 18 5 9 21 23 24 15 4  
T H E Y H A D O L Z Y O Z W A I R O L L C N Z X S

D-33

TOPIC 3-1: Related Angles Formed by Parallel Lines and Transversals

### What Is The Biggest Problem of Miners?

Circle the number-letter pair of each TRUE statement. For these pairs, write the letter in the matching numbered box at the right.

1 2 3 4 5 6 7 8 9 10 11 12 13 14 15 16 17 18  
T H E Y G E T C O A L F I R E T

I. Use the figure below, in which  $\overline{EF} \parallel \overline{BH}$ . You should find 11 true statements.

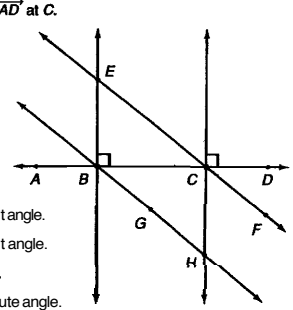

- 7-E  $\overline{EF}$  intersects  $\overline{AD}$  at C.
- 11-O  $\overline{EB} \perp \overline{AC}$
- 2-H  $\overline{FC} \parallel \overline{HG}$
- 17-E  $\overline{HC} \perp \overline{DB}$
- 1-T  $\overline{EB} \parallel \overline{CH}$
- 3-A  $\overline{BG} \perp \overline{CH}$
- 16-S  $\overline{CF} \parallel \overline{BE}$
- 12-A  $\angle EBC$  is a right angle.
- 18-G  $\angle DCE$  is a right angle.
- 3-E  $m\angle HCB = 90^\circ$ .
- 8-T  $\angle FCH$  is an acute angle.
- 16-E  $\angle LECH$  is an obtuse angle.
- 14-P  $\angle ABE$  is an acute angle.
- 4-Y Perpendicular lines intersect to form right angles.
- 18-T Parallel lines never intersect.
- 6-L  $m\angle DCH = m\angle EBH$

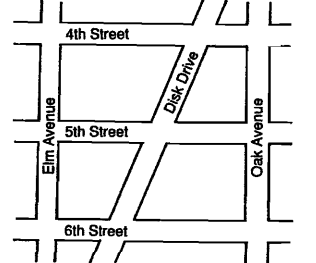

II. Use the figure above. You should find 4 true statements.

- 13-L 5th Street is parallel to 6th Street.
- 6-G 6th Street is perpendicular to Elm Avenue.
- 10-S Elm Avenue is parallel to Disk Drive.
- 15-F 4th Street and Oak Avenue intersect to form right angles.
- 9-N Elm Avenue is perpendicular to Oak Avenue.
- 10-C Elm Avenue is parallel to Oak Avenue.

TOPIC 3-4: Parallel and Perpendicular Lines

D-32

### What Did the Boy Candy Say to the Girl Candy?

Do each exercise and find your answer in the set of answers to the right. Write the letter of the answer in each box containing the number of the exercise. If the answer has a ●, shade in each box containing that exercise number.

I. Classify each triangle two ways.

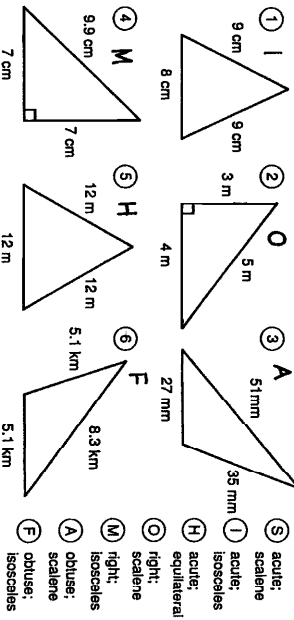

- (S) acute; scalene
- (L) acute; isosceles
- (H) acute; equilateral
- (O) right; scalene
- (M) right; isosceles
- (A) obtuse; scalene
- (F) obtuse; isosceles

II. Find the measure of the third angle in each triangle.

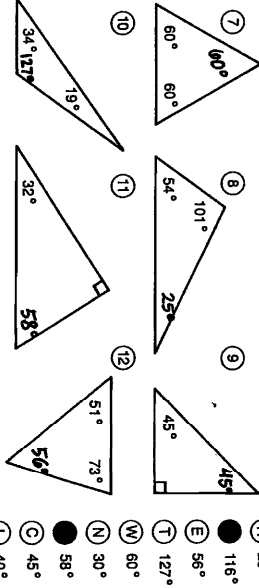

- (H) 25°
- (B) 116°
- (E) 56°
- (N) 30°
- (W) 60°
- (T) 127°
- (L) 40°

13. Two angles of a triangle have equal measures. If the third angle measures  $120^\circ$ , what is the measure of each of the equal angles?  $30^\circ$

7 12 11 3 8 12 11 4 1 13 10 11 6 2 8 11 21 3 8 5 11 2 10 5 12 8  
W E A R E M I N T F O R E A C H O T H E R

TOPIC 3-1: Triangles

D-34